



1074 Kenran Industrial Dr.
St. Louis, MO 63137
Phone: 1-800-381-9968

HUMCO DECK FITTINGS

Patterson Electric Winch

TOWBOAT WINCHES: The Electric Winch

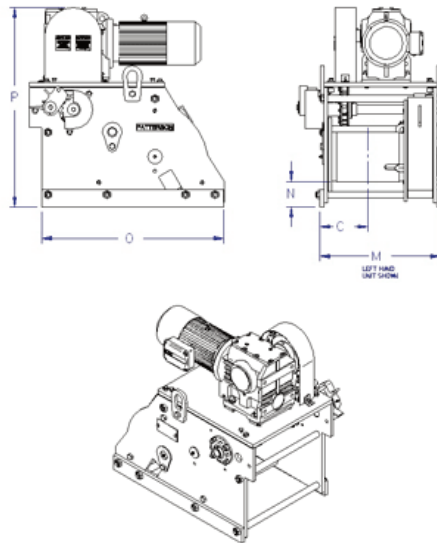

Patterson's full electric winches are designed for durability and ease of operation. Our electric winches are available from 20- to 90-ton capacities. Galvanized winches for optimal corrosion protection are also available.

- Optional saltwater-corrosion protection package includes stainless steel shafts, nuts and bolts, hot-dipped galvanized, and anti-seize on all threads or fasteners
- Thermostatically protected motor
- Machined alloy gearing
- NEMA 4 spring-loaded electric brake
- Manual locking dog for emergency backup use
- Heavy-duty roller chain, sprockets and roller bearings
- High-strength phosphor bronze bearings
- 208V or 230/460V-3 Phase-60Hz high torque motors (other voltages available)
- Bolted keeper plate allows fast, easy shaft removal
- Rope and gear guards protect wire rope and enclose the gearing

TONNAGE **HP** **VOLTAGE** **HAND**
WWP 40 E - 5.0 - 14 - 230 - G - R
POWER **DRUM WIDTH** **FINISH**

Performance Data* approximate (lbs.)							Drum Capacities* approximate					
	Dog Holding Capacity	Brake Holding Capacity	Line Pull 1st Wrap	Line Speed 1st Wrap	Stall Pull 1st Wrap	Ult Shock Load	1/2"	5/8"	3/4"	7/8"	1"	1 1/8"
WWP 20E-3.0	40,000	43,000	6987	14.7	20,900	40,000	220'	140'	100'	xx	xx	xx
WWP 30E-3.0	60,000	47,000	7600	13.4	23,000	60,000	xx	120'	85'	75'	xx	xx
WWP 30E-5.0	60,000	33,000	9000	18	33,000	60,000	xx	120'	85'	75'	xx	xx
WWP 40E-5.0	80,000	40,000	9,000	14.5	24,000	80,000	xx	xx	180'	130'	100'	xx
WWP 40E-7.5	80,000	75,000	9,900	18	40,500	80,000	xx	xx	180'	130'	100'	xx
WWP 65E-7.5	130,000	99,000	13,000	14	36,000	130,000	xx	xx	xx	230'	180'	150'
WWP 65E-12.5	130,000	80,000	16,000	24	47,000	130,000	xx	xx	xx	230'	180'	150'
WWP 75E-12.5	150,000	90,000	19,000	21	54,000	150,000	xx	xx	xx	xx	190'	150'

Dimensions* approximate (in.)							(lbs.)	
Drum Diameter	C	M	N	O	P		Weight Net	Approximate Shipping
WWP 20E-3.0	8.62	5.81	14.75	6.5	35	32.5	830	880
WWP 30E-3.0	10	8.81	19	5 67/77	35	32 32/33	1,015	1,065
WWP 30E-5.0	10	8.81	19	5 67/77	35	32 32/33	1,020	1,070
WWP 40E-5.0	10	9.19	24.5	5.16	37	40.15	1,415	1,465
WWP 40E-7.5	10	9.19	24.5	5.16	37	40.15	1,430	1,480
WWP 65E-7.5	14	10.75	25.75	6.5	38	48	2,140	2,190
WWP 65E-12.5	14	10.75	25.75	6.5	38	48	2,150	2,200
WWP 75E-12.5	16	8	22.25	8.25	45	52	2,400	2,450

* All performance data and specifications set forth in the above table are guidelines. The referenced data and specifications were produced under controlled testing conditions and should be used as estimates only. Due to variability in individual operators, in weather, in towing conditions, and in various other factors, actual results may vary. In addition, for the purpose of installation, please verify all dimensions as the dimensions, specifications, data and other information contained in this brochure are subject to change at any time without notice.



1074 Kenran Industrial Dr.
St. Louis, MO 63137
Phone: 1-800-381-9968

HUMCO DECK FITTINGS

Patterson Low-Profile Electric Winch

TOWBOAT WINCHES: The Low-Profile Electric Winch

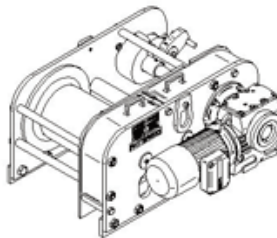
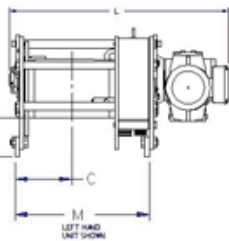
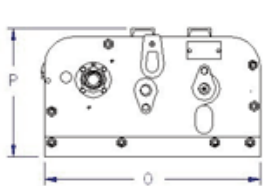

When winch height is limited, the Patterson Low-Profile Electric Winch is your solution.

- Manual locking dog for emergency use
- The Low-Profile electric winches provide high-line speed and high-line pull
- This series of winches range from 20-ton through 90-ton capacities
- The Low-Profile winch design has fewer parts creating lower maintenance
- Full rope guard to protect the wire rope from being fouled by the gearing
- Full gear shroud to protect gearing and help provide personal protection
- Units available in right or left hand models
- Motor sizes range from 3 HP to 12.5 HP, 208 Volt, 230/460 Volt, 3 phase with thermostat relays
- Galvanized winches for optimal corrosion protection available

TONNAGE **HP** **TYPE** **FINISH**
WWP 40 E - 5.0 - 14 - LP - 230 - G - R
POWER **DRUM WIDTH** **VOLTAGE** **HAND**

	Performance Data* approximate (lbs.)						Drum Capacities* approximate					
	Dog Holding Capacity	Brake Holding Capacity	Line Pull 1st Wrap	Line Speed 1st Wrap	Stall Pull 1st Wrap	Ult Shock Load	1/2"	5/8"	3/4"	7/8"	1"	1 1/8"
WWP 20E-3.0	40,000	24,500	3,400	27	10,000	40,000	220'	140'	100'	xx	xx	xx
WWP 30E-5.0	60,000	26,000	7,200	19	18,700	60,000	xx	120'	85'	65'	xx	xx
WWP 40E-5.0	80,000	22,000	6,000	23	15,800	80,000	xx	xx	180'	130'	100'	xx
WWP 40E-7.5	80,000	37,800	9,600	26.5	26,600	80,000	xx	xx	180'	130'	100'	xx
WWP 65E-7.5	130,000	39,000	10,000	25.5	27,600	130,000	xx	xx	xx	230'	180'	150'
WWP 75E-12.5	150,000	77,000	16,000	24.5	41,000	150,000	xx	xx	xx	xx	190'	150'

	Dimensions* approximate (in.)							(lbs.)	
	Drum Diameter	C	M	N	O	L	P	Weight Net	Approximate Shipping
WWP 20E-3.0	8.62	5.66	13.5	7	35	26.62	22.1	830	830
WWP 30E-5.0	10	7.5	17.62	6.5	35	31	21.94	1,020	1,020
WWP 40E-5.0	10	9.72	23	6.66	37	37.5	21.96	1,415	1,415
WWP 40E-7.5	10	9.72	23	6.66	37	38.02	21.96	1,430	1,430
WWP 65E-7.5	14	9	23.75	7.25	40	38	30.28	2,140	2,140
WWP 75E-12.5	16	10	28.75	8	45	51.61	38	2,400	2,400



1074 Kenran Industrial Dr.
St. Louis, MO 63137
Phone: 1-800-381-9968

HUMCO DECK FITTINGS

Patterson Upright Winch

TOWBOAT WINCHES: The Upright Winch

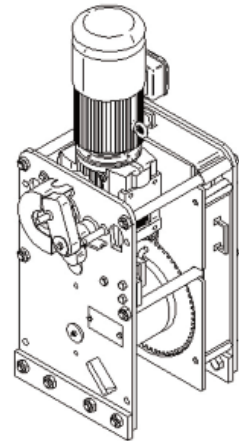
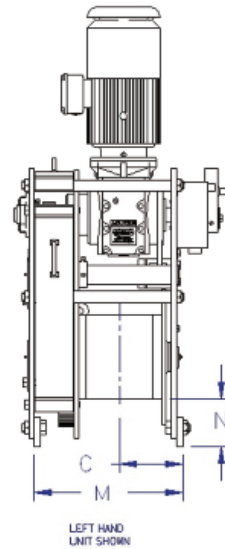
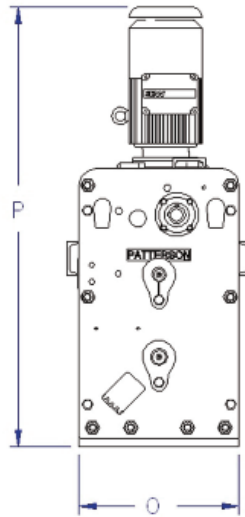
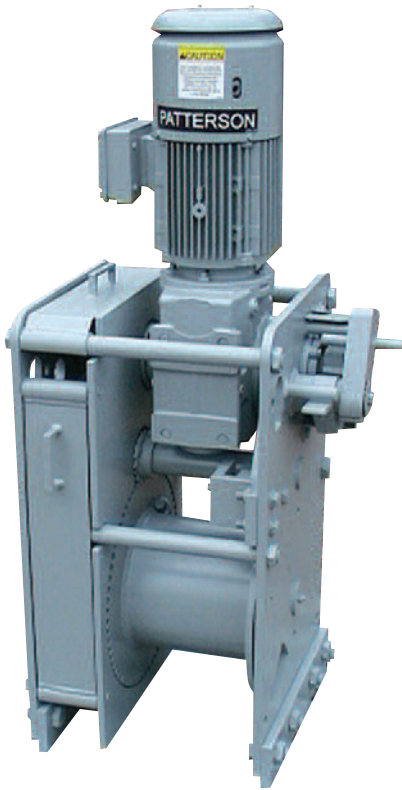

LEFT HAND
UNIT SHOWN

TONNAGE **HP** **TYPE** **FINISH**
WWP 30 E - 5.4 - 10 - U - 230 - G - R
POWER **DRUM WIDTH** **VOLTAGE** **HAND**

Performance Data* approximate (lbs.)							Drum Capacities* approximate					
Dog Holding Capacity	Brake Holding Capacity	Line Pull 1st Wrap	Line Speed 1st Wrap	Stall Pull 1st Wrap	Ult Shock Load		1/2"	5/8"	3/4"	7/8"	1"	1 1/8"
WWP 30E-5	60,000	46,800	10,800	16	30,300	60,000	xx	120'	85'	65'	xx	xx

Dimensions* approximate (in.)							(lbs.)	
Drum Diameter	C	M	N	O	P		Weight Net	Approximate Shipping
WWP 30E-5	10	7.5	17.62	5.62	19	52.14	640	690

* All performance data and specifications set forth in the above table are guidelines. The referenced data and specifications were produced under controlled testing conditions and should be used as estimates only. Due to variability in individual operators, in weather, in towing conditions, and in various other factors, actual results may vary. In addition, for the purpose of installation, please verify all dimensions as the dimensions, specifications, data and other information contained in this brochure are subject to change at any time without notice.



1074 Kenran Industrial Dr.
St. Louis, MO 63137
Phone: 1-800-381-9968

HUMCO DECK FITTINGS

Patterson Hydraulic Winch

TOWBOAT WINCHES: The Fully Hydraulic Winch

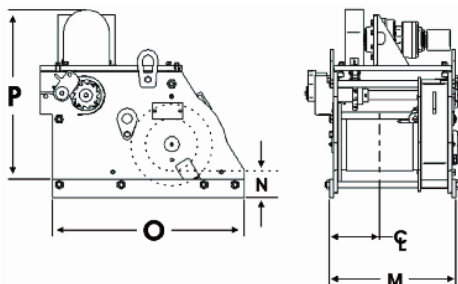
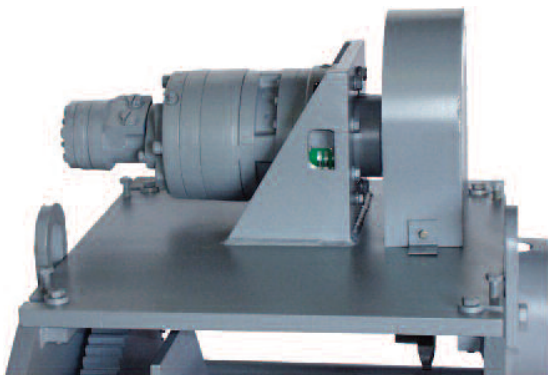

The Patterson fully Hydraulic Winch is designed for durability and ease of operation. Our hydraulic winches are available from 20- to 90-ton capacities. Galvanized winches for optimal corrosion protection are also available.

- Optional saltwater-corrosion protection package includes stainless steel shafts, nuts and bolts, hot-dipped galvanized, and anti-seize on all threads or fasteners
- Disc brake is motor-mounted, fully enclosed, spring-applied and hydraulically released
- Manual locking dog for emergency use
- Vary take-up speed simply by varying input flow
- Heavy-duty roller chain and sprockets
- Heavy-duty roller bearings, high-strength phosphor bronze bearings
- Operates from vessel's existing hydraulic system
- High efficiency planetary gear head
- Bolted keeper plate allows fast, easy shaft removal
- Rope and gear guards protect wire rope and enclose the gearing
- Brake, shuttle valves and controls available upon request

	Performance Data* approximate (lbs.)				Drum Capacities* approximate						
	Brake/Dog Holding Capacity	Line Speed 1st Wrap	Stall Pull 1st Wrap	Hydraulic Supply	1/2"	5/8"	3/4"	7/8"	1"	1 1/8"	1 1/4"
WWP 20H-6-L/R	40,000	21	15,000	16 GPM at 2,000 psi	220"	140"	100"	xx	xxx	xxx	xxx
WWP 30H-10-L/R	60,000	20	19,000	20 GPM at 2,000 psi	xx	120'	85'	65'	xx	xx	xx
WWP 40H-14-L/R	80,000	21	20,000	20 GPM at 2,250 psi	xx	xx	180'	130'	100'	xx	xx
WWP 50H-14-L/R	100,000	22	21,000	20 GPM at 2,250 psi	xx	xx	180'	130'	100'	xx	xx
WWP 65H-14-L/R	130,000	16	27,000	20 GPM at 2,250 psi	xx	xx	xx	230'	180'	150'	xxx
WWP 75H-10-L/R	150,000	12	37,000	20 GPM at 2,250 psi	xx	xx	xx	xx	190'	150'	125'

11

	Dimensions* approximate (in.)							(lbs.)	
	Drum Diameter	Drum Width	C/L	M	N	O	P	Net	Shipping
WWP 20H-6-L/R	8.625	6.875	5.8125	15	5.5	35	32.75	800	850
WWP 30H-10-L/R	10	10	8.8125	19	4.875	35	32.75	1,000	1,050
WWP 40H-14-L/R	10	14.375	9.1875	24.5	4	37	38.5	1,400	1,450
WWP 50H-14-L/R	10	14.375	9.1875	24.5	4	37	40	1,450	1,500
WWP 65H-14-L/R	14	14	10.75	25.75	5.5	40	48	2,125	2,175
WWP 75H-10-L/R	16	10	8	22.25	8.25	45	52	2,375	2,475

* All performance data and specifications set forth in the above table are guidelines. The referenced data and specifications were produced under controlled testing conditions and should be used as estimates only. Due to variability in individual operators, in weather, in towing conditions, and in various other factors, actual results may vary. In addition, for the purpose of installation, please verify all dimensions as the dimensions, specifications, data and other information contained in this brochure are subject to change at any time without notice.