



1074 Kenran Industrial Dr.  
St. Louis, MO 63137  
Phone: 1-800-381-9968

## Teleflex® Control Cables

### SHIFT AND THROTTLE CONTROL CABLES

The control cable is a very important component in the control system. It is the vital link between the control head and the propulsion unit. Employing the best cable helps insure that your shift and throttle system operates smoothly and efficiently. The design, technology, and materials which are used in Teleflex Marine cables have literally set the standard for the entire marine industry.

Our control cables are environmentally tested for marine applications. They have stainless steel terminals and conduit fittings as well as stainless or

nylon covered core wires with moisture protective seals for added corrosion protection and longer life. Their durable HDPE outer jackets resist abrasion and withstand the effects of UV, salt water, chemicals, gasoline, and oil. Each Teleflex Marine cable is lifetime lubricated at the factory.

Teleflex Marine pioneered the development of high efficiency control cables. Since not all cables utilize this technology there can be significant operating differences between Teleflex Marine cables and other brands.

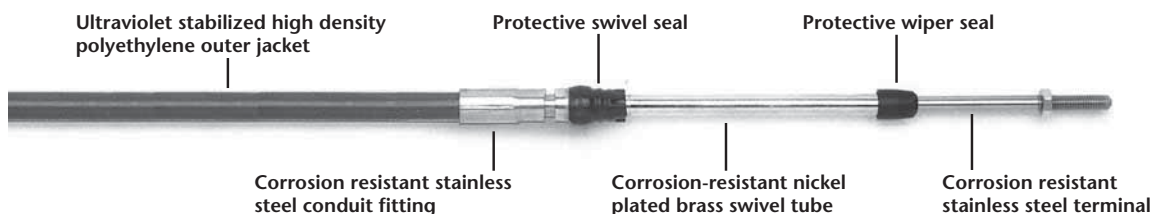

6

### HOW TO CHOOSE THE RIGHT 3300/33C CABLE:

Teleflex Marine offers several models of universal 3300/33C type cables, each suited to certain operating conditions and installation parameters. Below are key variables that affect how cables perform:

**Backlash:** the lost motion between the amount of movement put in (input end of the cable) and the amount of movement which occurs at the output end of the cable. Some motion is generally lost in “take up” between the inner wire (core) of the cable and the outer casing (conduit). Backlash manifests itself as free play (slop) felt at the control handle.

**Efficiency:** the percentage of input force that is transmitted through the cable as output force. For example, if a 10-pound force was exerted on the cable at its input end and resulted in the cable exerting an 8-pound output force, the cable would be 80% efficient.

**Breakaway:** the “feel” of the cable when put into motion; the breakaway threshold is the force that must be applied to the cable’s input end before something happens at the output end. An example of excessive breakaway: a control that would have to be moved to

**Cable Routing:** the shorter and straighter the cable routing, the better the cable will perform. With increased length and bends, cable efficiency is reduced, while breakaway and backlash rise.

**Environment:** generally, the more rugged the cable construction, the longer the cable will last. In harsh environments such as heavy salt and UV exposure, control cables with thicker conduits and stainless steel fittings will generally outlast those with thinner conduits and brass or steel fittings.

Cable design, manufacturing tolerances, length and installation care are additional factors to consider.

3300/33C CABLE TYPE	BACK-LASH	BREAK-AWAY/ EFFICIENCY	LONG/ COMPLEX ROUTINGS	HARSH ENVIRONMENT
CC230/CC172	Good	Good	N/A	Good
CC332	Better	Better	Better	Better
CCX633 <b>TF&gt;XTRME</b>	Superior	Superior	Superior	Superior

For definitions of terms used in this chart, see the accompanying article on page 403.



1074 Kenran Industrial Dr.  
St. Louis, MO 63137  
Phone: 1-800-381-9968

# HUMCO ENGINE CONTROLS

## Teleflex® Control Cables

### WHAT TO CONSIDER WHEN SELECTING CABLES

Teleflex Marine makes engine control cables for a wide variety of applications. We recommend their use with our controls as well as in engine manufacturers' control systems.

We offer three grades of cable: standard, midrange and **TFXTREME**.

#### THREE PERFORMANCE GRADES:

**TFXTREME** control cables can be used in any boat. They are by far the best choice for long runs, twin stations or other difficult routings with multiple cable bends.

Midrange cables are recommended for somewhat longer cable routings and heavier use than their standard counterparts.

Standard cables are suitable for most applications with short, simple cable routings.

#### FOUR APPLICATION TYPES:

##### OEM Replacement Type

Teleflex offers a direct replacement cable for almost every engine manufacturer's control. Most of our OEM type cables are available in both standard and **TFXTREME** versions.

##### Universal (3300/33C) Type

Universal (or 3300/33C) type throttle/shift control cables are direct replacements for many boats using aftermarket controls or most engine manufacturer's controls with the correct adapter kit. Universal 3300/33C cables can be connected to most engines. These cables are offered in all three grades: standard, midrange and **TFXTREME**.

##### Universal (4300/43 6400/64) Types

Heavy duty universal type control cables are available in **TFXTREME** versions only. These are drop-in replacements for 43C, 43BC, 64C and 64BC and other similar cables.

##### Jet Boat Gate Control Cables

Three styles of drive-specific jet boat gate control cables are available, for Mercury Sport Jet® 90 and early 120s, Sport Jet 175s and OMC Turbo Jet®. Our **TFXTREME** 43BC cable is used on most other popular jet drives. Replacement throttle control cables are generally an OEM or 3300/33C Universal type.



Teleflex Marine control cables meet OEM specifications for fit, function, reliability and quality. They are built with marine-grade, corrosion-resistant materials and feature either **TFXTREME** premium core construction or Lubri-Core™ lifetime internal lubrication.



1074 Kenran Industrial Dr.  
St. Louis, MO 63137  
Phone: 1-800-381-9968

# HUMCO ENGINE CONTROLS

## Teleflex® Measuring Cables

### HOW TO MEASURE CONTROL CABLES "MEASURE TWICE. ORDER ONCE."

#### FOR A NEW INSTALLATION:

Measure cable routing path from control head attachment point to engine connection, as follows:

#### OUTBOARDS:

Measure from control along unobstructed cable routing to center of outboard. Add four feet to allow for loop which provides unrestricted engine movement. Round up to the next foot and order required cable part number. (Last two digits of cable part number equal cable length in feet.)

#### TYPICAL OUTBOARD CABLE ROUTING:

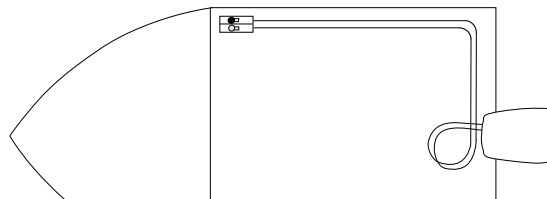

TYPICAL OUTBOARD CABLE ROUTING  
(MEASURE CABLE PATH + ROUND UP TO NEXT EVEN FOOT + ADD 4 FEET FOR LOOP AT ENGINE TO PREVENT KINKING)

#### TYPICAL STERN DRIVE (I/O) OR INBOARD CABLE ROUTING:

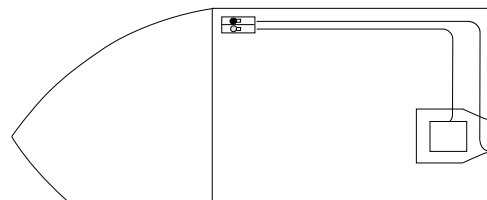

TYPICAL STERN DRIVE/INBOARD CONTROL CABLE ROUTING  
(MEASURE CABLE PATH + ROUND UP TO NEXT EVEN FOOT)

6

#### INBOARDS & STERN DRIVES:

Measure from control along unobstructed cable routing to shift and/or throttle connection. Round this dimension up to the next foot and order required cable part number. (Last two digits of cable part number equal cable length in feet.)

#### FOR REPLACEMENT OF EXISTING CABLE:

If you removed the old cable, measure for replacement cable as follows:

Measure from tip to tip and round up to the next foot, if necessary (aftermarket cables are sold in foot increments).

The control cable part number contains its length. Teleflex cables are usually listed as CC???XX, where XX = length in feet.

#### FOR EXAMPLE:

Part Number CCX63320 = 20 ft. CCX633  
Control Cable

or

Morse® Part Number 032377-03-240.0 = 20 ft. 33C  
Control Cable

(240" = 20')

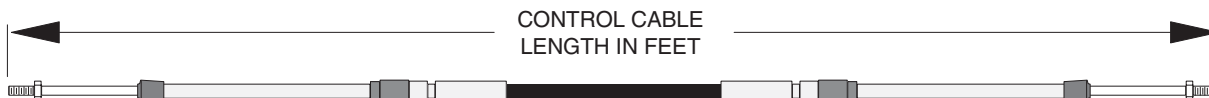



1074 Kenran Industrial Dr.  
St. Louis, MO 63137  
Phone: 1-800-381-9968

# HUMCO ENGINE CONTROLS

## Teleflex® TFXTREME Control Cables

# TFXTREME®

### REALLY DIFFERENT

Traditional cables vary by the stiffness of the core wire and how tightly it fits in the casing. Thus the classic trade-offs that have existed in control cable design:

Stiffer core/tighter fit offers less lost motion, but is harder to move. With longer and more complex runs, cable movement becomes progressively more difficult.

More flexible core/looser fit has an easier feel, but allows more lost motion. This approach leads to an overall sloppy feel, RPM loss or difficult gear engagement.

These trade-offs aren't an issue for cables with **TFXTREME** technology because they are different — really different!

Teleflex's unique **TFXTREME** technology incorporates a patented splined core.

Ridges on the core allow a close fit with the cable's inner liner, but with minimum contact, so the core glides back and forth smoothly like a skater on ice.

RESULT: a control cable with easy movement AND minimum lost motion.

### THE CORE DIFFERENCE:

.34" Super Tough HDPE Jacket for Ultimate Protection Against the Elements.

Oil Tempered Lay Wires for Superior Strength & Performance.

UNIQUE SPLINED CORE!

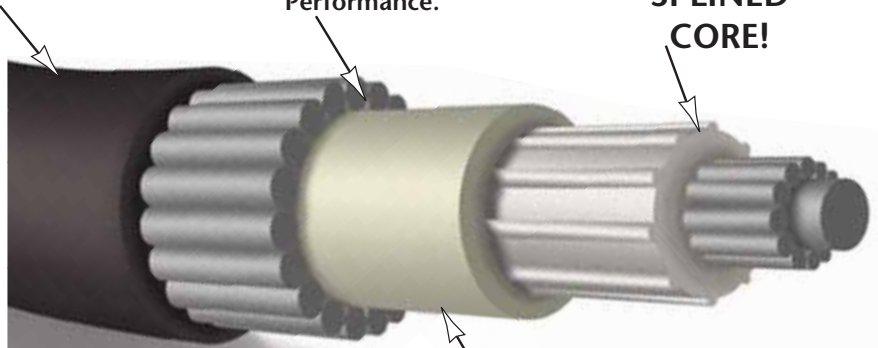

Long Wearing HDPE Liner: Ultra Smooth and Lubed for Life.

### CROSS SECTION OF CORE AND LINER:

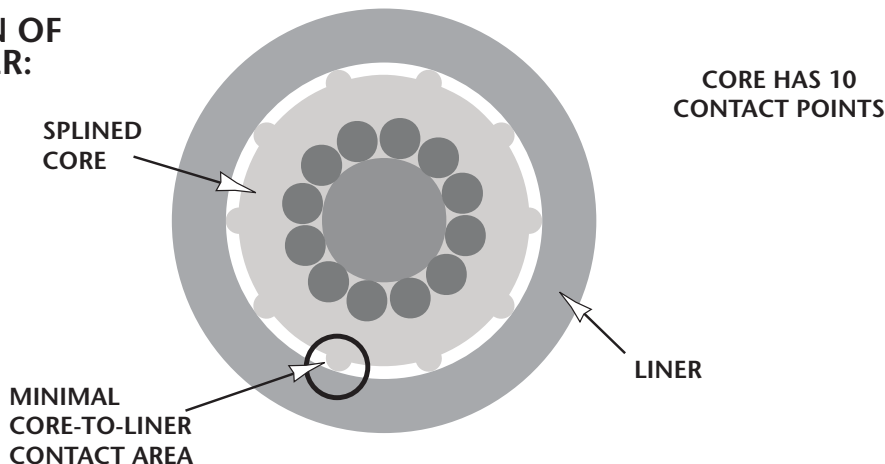



1074 Kenran Industrial Dr.  
St. Louis, MO 63137  
Phone: 1-800-381-9968

# HUMCO ENGINE CONTROLS

## Teleflex® TFX<sup>XTREME</sup> Control Cables

### A COMPLETE FAMILY OF CABLES:



Teleflex Marine  
**TFX<sup>XTREME</sup>** technology cables are  
the **ONLY** high performance cable family  
with a **FULL RANGE** of universal cables and  
**ALL** popular direct replacement OEM type cables.





1074 Kenran Industrial Dr.  
St. Louis, MO 63137  
Phone: 1-800-381-9968

# HUMCO ENGINE CONTROLS

## Teleflex® OEM Control Cables

### OEM CABLE APPLICATIONS:

OEM direct-replacement type cables are designed to fit BRP® Mercury®, Mariner®, OMC®, Volvo® and similar OEM engine control heads which use a proprietary control cable connection. **TFXTREME** versions of the most popular cables are offered for demanding applications in which a smooth feel at the control is essential.

### FOR THESE CONTROLS:

Mercury®, MerCruiser®, Mariner®, Force®, OMC®, Evinrude®, Johnson®, Volvo®, Teleflex Osprey Series CH1700, CH7500, CH7600, and CH7800

MERCURY/MARINER/FORCE/U.S. MARINE:	
Mercury Gen II type (standard)	CC189XX
Mercury Gen II type (premium)	CCX189XX
Mariner®/Mercury®/MerCruiser® and other engines using Mercury 2003-date 4000 series controls. CCX189XX is a <b>TFXTREME</b> cable.	
Mercury 600A type (standard)	CC179XX
Mercury 600A type (premium)	CCX179XX
Mariner®/Mercury®/MerCruiser® (1965-date); Force® (1993-date) with Mercury controls. All Mariner engines with Mercury/Mariner controls (except pre-1993 40 HP & lower models). All 1993-date Force (US Marine) with Force/US Marine/Mercury controls. CCX179XX is a <b>TFXTREME</b> cable.	
Mariner 630 type (standard)	CC210XX
Mariner® (pre-1993 40 HP & less) with Mariner/Mercury controls.	
Mercury 3600 type (premium)	CCX630XX
Mercury® products (1965-date); Force® (1993-date) using Mercury controls which accept 10-32 threaded ends or using most aftermarket controls. Mercury style engine end connection.	
US Marine® L-Drive shift cable (std.)	CC213XX
U.S. Marine "L-Drive" engines with original equipment controls. Drop-in replacement for "L-Drive" shift cables.	

### FEATURES:

- Drop-in replacement cables are engineered as replacements for original equipment cables.
- Cables use the existing connection components.
- Stainless steel and brass fittings.
- Standard cables use stainless steel Lubri-Core™ core wire for smooth operation and long life. (8" minimum bend radius.)
- Premium cables have a heavy jacket and the **TFXTREME** splined, coated core element for maximum smoothness with minimal lost motion. (4" min. bend radius.)
- Black HDPE outer casing for durability and best resistance to UV and chemicals.
- Red conduit international only.

BRP, OMC, JOHNSON, EVINRUDE, VOLVO/OMC:	
400 type (standard)	CC170XX
Pre-1979 OMC®/Johnson®/Evinrude® with BRP/OMC controls. Exceeds engine manufacturer's specifications.	
479 type (standard)	CC205XX
479 type (premium)	CCX205XX
1979-date BRP®/OMC®/Johnson®/Evinrude®/Gale® with BRP/OMC controls. Exceeds engine manufacturer's specifications. CC736 uses Supreme type coated core wire; CCX205XX is a <b>TFXTREME</b> cable.	
Volvo/OMC cable (premium)	CCX214XX
Volvo engines using BRP/OMC side mount controls.	
Volvo/OMC cable (premium)	CCX740XX
Volvo engines using top mount BRP/OMC controls.	

6





1074 Kenran Industrial Dr.  
St. Louis, MO 63137  
Phone: 1-800-381-9968

# HUMCO ENGINE CONTROLS

## Teleflex® OEM Cross Reference Control Cables

EXISTING PART NUMBER	DESCRIPTION	PART NUMBER TO REORDER		Conduit Color / End Metal
		Standard	Premium	
MERCURY/MARINER - STANDARD CABLE CC179XX	600A Series Control Cable Assembly			black/brass
6' - 9' specialty length cables (NLA - all markets) use premium <b>TRXtreme</b> cables		N/A	CCX179XX	black/brass
10' - 24' length cables (Aftermarket)		CC179XX	CCX179XX	black/brass & stainless
10' - 24' length cables use premium <b>TRXtreme</b> cables		N/A	CCX179XX	black/stainless
25' - up specialty length cables (NLA - all markets) use premium <b>TRXtreme</b> cables		N/A	CCX179XX	black/stainless
CC189XX	Gen II Series Control Cable			black/brass
6' - 9' specialty length cables (NLA - all markets) use premium <b>TRXtreme</b> cables		N/A	CCX189XX	black/brass
10' - 24' length cables (Aftermarket)		CC189XX	CCX189XX	black/brass & stainless
10' - 24' length cables use premium <b>TRXtreme</b> cables		N/A	CCX189XX	black/stainless
25' - up specialty length cables (NLA - all markets) use premium <b>TRXtreme</b> cables		N/A	CCX189XX	black/stainless
CC210XX	630 Mariner Series Control Cable			black/brass & stainless
6' - 9' specialty length cables (NLA - all markets)		N/A	N/A	
10' - 24' length cables (Aftermarket)		CC210XX	N/A	black/brass & stainless
25' - up specialty length cables (NLA - all markets)		N/A	N/A	
MERCURY/MARINER - PREMIUM CABLE CC630XX	3600 Control Cable Assembly			black/stainless
All lengths (all markets) superseded to new part number		N/A	CCX630XX	black/stainless
CC635XX	600A Control Cable Assembly			black/stainless
All lengths (all markets) superseded to new part number		N/A	CCX179XX	black/stainless
CC679XX	Gen II Control Cable			black/stainless
All lengths (all markets) superseded to new part number		N/A	CCX189XX	black/stainless
BRP, OMC, EVINRUDE, JOHNSON - STANDARD CABLES CC205XX	479 Series Control Cable Assembly			black/brass
6' - 9' specialty length cables (NLA - all markets) use premium <b>TRXtreme</b> cables		N/A	CCX205XX	black/brass
10' - 24' length cables (Aftermarket)		CC205XX	CCX205XX	black/brass & stainless
25' - up specialty length cables (NLA - all markets) use premium <b>TRXtreme</b> cables		N/A	CCX205XX	black/stainless
CC170XX	400 Series Control Cable Assembly			black/brass
6' - 24' specialty length cables (Aftermarket)		CC170XX	N/A	black/brass
25' - up specialty length cables (NLA - all markets)		N/A	N/A	black/stainless
BRP, OMC, EVINRUDE, JOHNSON - PREMIUM CABLES CC636XX	479 Series Control Cable Assembly			black/stainless
All lengths (all markets) superseded to new part number		N/A	CCX205XX	black/stainless
CC214XX	OMC, Volvo Penta, Side Mount Control Cable			black/brass
All lengths (North America Aftermarket) superseded to new part number		N/A	CCX214XX	black/brass & stainless
CC740XX	OMC, Volvo Penta, Top Mount Control Cable			black/brass
All lengths (North America Aftermarket) superseded to new part number		N/A	CCX740XX	black/brass & stainless

NOTES  
XX = Length in feet



1074 Kenran Industrial Dr.  
St. Louis, MO 63137  
Phone: 1-800-381-9968

# HUMCO ENGINE CONTROLS

## Teleflex® Selection Guide Control Cables

### CONTROL CABLE OPTIONS BASED ON ENGINE TYPE:

OUTBOARD ENGINES:	STANDARD GRADE USING ENG. MFR. CONTROLS	STANDARD GRADE USING AFTMKT. CONTROLS
Chrysler®	CC172XX/CC230XX + ball joint kit*	CC172XX/CC230XX + ball joint kit*
Force® pre-1993 Force® 1993-date	CC172XX/CC230XX + ball joint kit* CC179XX (600A type)	CC172XX/CC230XX + ball joint kit* CC172XX/CC230XX + CA27319P kit**
Johnson®/Evinrude® 1979-date Johnson®/Evinrude® pre-1979	CC205XX (479 type) CC170XX (400 type)	CC172XX/CC230XX + CA27320P kit** CC172XX/CC230XX + CA27321P kit**
Mariner® 40 HP & below pre-1993 Mariner® 40 HP & below 1993-date Mariner® all above 40 HP	CC210XX (630 type) CC179XX (600A type) CC179XX (600A type)	CC172XX/CC230XX CC172XX/CC230XX + CA27319P kit** CC172XX/CC230XX + CA27319P kit**
Mercury® 1965-date Mercury® products 2003-date (4000 series Gen II controls)	CC179XX (600A type) CC189XX (Gen II type)	CC172XX/CC230XX + CA27319P kit** N/A
Honda®, Nissan®, Suzuki®, Tohatsu®, Yamaha®	CC172XX/CC230XX	CC172XX/CC230XX

### STERNDRIVE (I/O) AND SOME INBOARDS:

Chrysler®, All Inboards	CC172XX/CC230XX	CC172XX/CC230XX
MerCruiser®, All Stern Drives (except 4000 series controls) MerCruiser® 2003-date (using 4000 series controls) Mercury®, All Inboards (except 4000 series controls) Mercury® Inboards 2003-date (using 4000 series controls)	CC179XX (600A type) CC189XX (Gen II type) CC179XX (600A type) CC189XX (Gen II type)	CC172XX/CC230XX + CA27319P kit** N/A CC172XX/CC230XX + CA27373P kit** N/A
OMC® 1979-date OMC® pre-1979	CC205XX (479 type) CC170XX (400 type)	CC172XX/CC230XX + CA27320P kit** CC172XX/CC230XX + CA27321P kit**
Volvo® using Volvo® controls Volvo® using OMC® controls Volvo® Turbo, SX, new-gen OMC drives w/OMC® controls	CC172XX/CC230XX N/A N/A	CC172XX/CC230XX N/A N/A
Others	CC172XX/CC230XX	CC172XX/CC230XX

### HEAVY DUTY APPLICATIONS, INCLUDING SOME INBOARD & JET ENGINES:

1/4-28 terminal, 1 bulkhead, 1 clamp fitting (43BC) 1/4-28 terminal, 2 clamp fittings (43C)	(see Premium Grade) (see Premium Grade)	(see Premium Grade) (see Premium Grade)
5/16-24 terminal, 1 bulkhead, 1 clamp fitting (64BC) 5/16-24 terminal, 2 clamp fittings (64BC)	(see Premium Grade) (see Premium Grade)	(see Premium Grade) (see Premium Grade)

### JET ENGINES (MERCURY SPORT JET®, OMC TURBO JET® & SIMILAR):

Mercury® Sport Jet 90 & 120 (throttle cable) Mercury® Sport Jet 90 & early 120 (gate cable) Mercury® Sport Jet 175 (gate cable)	CC172XX/CC230XX + CA27319P kit** CC213XX N/A	CC172XX/CC230XX + CA27319P kit** CC213XX N/A
OMC® Turbo Jet (throttle control cable) OMC® Turbo Jet (gate control cable)	CC205XX (479 type) N/A	CC172XX/CC230XX + CA27320P kit** N/A

\* Proprietary ball joint type cable adapter kit required to complete connection to the engine. This part (formerly Teleflex P/N CA27019P) is no longer available from Teleflex.

\*\* Cable adapter kits listed are required to complete connection to the engine. Consult engine manufacturer, dealer or distributor .





1074 Kenran Industrial Dr.  
St. Louis, MO 63137  
Phone: 1-800-381-9968

# HUMCO ENGINE CONTROLS

## Teleflex® Selection Guide Control Cables

General rule: use direct replacement type cable whenever possible;  
use **TFXTREME** cables for difficult routings/multiple stations.

MIDRANGE GRADE USING ENG. MFR. CONTROLS		MIDRANGE GRADE USING AFTMKT. CONTROLS		PREMIUM GRADE (TFXTREME) USING ENG. MFR. CONTROLS		PREMIUM GRADE (TFXTREME) USING AFTMKT. CONTROLS	
CC332XX + + ball joint kit*		CC332XX + ball joint kit*		CCX633XX + ball joint kit*		CCX633XX + ball joint kit*	
N/A		CC332XX CC332XX + CA27319P**		CCX633XX + ball joint kit* CCX179XX (600A type)		CCX633XX + ball joint kit* CCX630XX	
N/A		CC332XX + CA27320P**		CCX205XX (479 type)		CCX633XX + CA27320P kit**	
N/A		CC332XX + CA27319P**		N/A		CCX633XX + CA27321P kit**	
N/A		CC332XX		N/A		CCX633XX	
N/A		CC332XX + CA27319P**		CCX179XX (600A type)		CCX630XX	
N/A		CC332XX + CA27319P**		CCX179XX (600A type)		CCX630XX	
N/A		CC332XX + CA27319P**		CCX179XX (600A type)		CCX630XX	
N/A		CC332XX + CA27319P**		CCX179XX (600A type)		CCX630XX	
N/A		N/A		CCX189XX (Gen II type)		N/A	
CC332XX		CC332XX		CCX633XX/TFXTREME		CCX633XX	
CC332XX		CC332XX		CCX633XX		CCX633XX	
N/A		CC332XX		CCX179XX (600A type)		CCX630XX	
N/A		N/A		CCX189XX (Gen II type)		N/A	
N/A		CC332XX		CCX179XX (600A type)		CCX630XX	
N/A		N/A		CCX189XX (Gen II type)		N/A	
N/A		CC332XX		CCX205XX (479 type)		CCX633XX + CA27320P kit**	
N/A		CC332XX		N/A		CCX633XX + CA27321P kit**	
CC332XX		CC332XX		CCX633XX		CCX633XX	
N/A		N/A		CCX214XX*** or CCX740XX		N/A	
N/A		N/A		CCX214XX*** or CCX740XX		N/A	
CC332XX		CC332XX		CCX633XX		CCX633XX	
(see Premium Grade)		(see Premium Grade)		CCX430XX (replaces Morse® 43BC)		CCX430XX (replaces Morse® 43BC)	
(see Premium Grade)		(see Premium Grade)		CCX433XX (replaces Morse® 43CC)		CCX433XX (replaces Morse® 43CC)	
(see Premium Grade)		(see Premium Grade)		CCX640XX (replaces Morse® 64BC)		CCX640XX (replaces Morse® 64BC)	
(see Premium Grade)		(see Premium Grade)		CCX643XX (replaces Morse® 64CC)		CCX643XX (replaces Morse® 64CC)	
CC332XX + CA27319P kit**		CC332XX + CA27319P**		CCX630XX		CCX630XX	
N/A		N/A		N/A		N/A	
CC400XX		CC400XX		N/A		N/A	
N/A		CC332XX		CCX205XX (479 type)		CCX633XX + CA27320P kit**	
N/A		CC332XX		CCX214XX*** or CCX740XX***		CCX633XX	

\*\*\* Cable part numbers shown are for OMC side-mount controls (CCX214XX); OMC binnacle-mount controls (CCX740XX).



1074 Kenran Industrial Dr.  
St. Louis, MO 63137  
Phone: 1-800-381-9968

# HUMCO ENGINE CONTROLS

## Teleflex® Universal 3300/33C Control Cables

### UNIVERSAL 3300/33C APPLICATIONS:

Universal type cables are designed to fit aftermarket engine controls as well as OEM units from BMW®, Chrysler®, Honda®, Nissan®, Suzuki®, Volvo®, Yamaha® and others. Several versions of the 3300/33C type are available, including a **TFXtreme** model.

**TFXtreme** versions of the 3300/33C cables are offered for demanding applications in which a smooth feel at the control is essential.

3300/33C TYPES (10-32 ENDS):		
3300 cable (standard)	CC230XX/ CC172XX	Stainless Fittings Brass Fittings
Cable has a 10-32 threaded terminal and a clamp-type fitting at each end. 3" nominal travel.		
33C cable (midrange)	CC332XX	Red Conduit
Cables have a 10-32 threaded terminal and a clamp-type fitting at each end. 3" nominal travel.		
<b>TFXtreme</b>		
3300 cable (premium)	CCX633XX	Stainless Fittings
Cable has a 10-32 threaded terminal and a clamp-type fitting at each end. 3" nominal travel. 4" minimum bend radius.		

### FEATURES:

- Cables can use the existing connection components.
- Stainless steel and brass fittings.
- Standard cables use stainless steel Lubri-Core™ core wire for smooth operation and long life. (8" minimum bend radius.)
- Midrange cables use a heavier jacket and a stainless steel Lubri-Core™. (8" minimum bend radius for Lubri-Core construction)
- Premium 3300/33C cables have a heavy jacket and the **TFXtreme** splined, coated core element for maximum smoothness with minimal lost motion. (4" min. bend radius.)
- Black HDPE outer casing for durability and best resistance to UV and chemicals.

6

### FOR THESE CONTROLS:

Teleflex Marine® and other brands which accept "universal" type control cables.



### NEW CABLE CONSTRUCTION

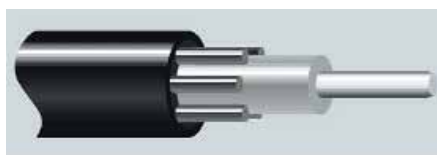

**OLD CONSTRUCTION CC172XX**

- 6 Lay wires.
- Brass conduit fittings.



**NEW CONSTRUCTION CC230XX**

- 16 Lay wires.
- Stainless Steel conduit fittings.



1074 Kenran Industrial Dr.  
 St. Louis, MO 63137  
 Phone: 1-800-381-9968

# HUMCO ENGINE CONTROLS

## Teleflex® Universal 3300/33C Control Cables

EXISTING PART NUMBER	DESCRIPTION	PART NUMBER TO REORDER		Conduit Color / End Metal
		Standard	Premium	
CC230XX/CC172XX 6' - 9' specialty length cables (NLA - all markets) use premium <b>TX</b> cables	3300 Series Control Cable Assembly	N/A	CCX633XX	CC230XX black/stainless CC172XX black/brass black/stainless
10' - 24' length cables (Aftermarket Only) 25' - up specialty length cables (NLA - all markets) use premium <b>TX</b> cables		CC230XX / CC172XX	CCX633XX	CC230XX black/stainless CC172XX black/brass CCX633XX black/stainless
CC330XX 6' - 9' specialty length cables (NLA - all markets) use premium <b>TX</b> cables	3300 Series Control Cable Assembly	N/A	CCX633XX	black/stainless black/stainless
10' - 24' length cables use premium <b>TX</b> cables		N/A	CCX633XX	black/stainless black/stainless
25' - up specialty length cables (NLA - all markets) use premium <b>TX</b> cables		N/A	CCX633XX	black/stainless black/stainless
03237-03-XXX.0 6' - 9' specialty length cables (NLA - all markets) use premium <b>TX</b> cables	33C Control Cable	N/A	CCX633XX	black/stainless <b>red/stainless</b>
10' - 24' length cables (NLA - Aftermarket) use premium <b>TX</b> cables		N/A	CCX633XX	CCX633XX black/stainless CCX633XX black/stainless
25' - up specialty length cables (NLA - all markets) use premium <b>TX</b> cables		N/A	CCX633XX	CCX633XX black/stainless CCX633XX black/stainless
301947-03-XXX.0 All lengths (NLA - North America Aftermarket) use premium <b>TX</b> cables	33C Supreme Control Cable	N/A	CCX633XX	CCX633XX black/stainless <b>red/stainless</b>
CC633XX All lengths (NLA - all markets) superseded to new part number	3300 Premium <b>TX</b> Control Cable Assembly	N/A	CCX633XX	black/stainless black/stainless

NOTES  
 XX = Length in feet  
**Red text denotes red conduit cable**

3300/33C type cables (1-0-32 end threads)  
 Engines and connection kits that accept a 1-0-32 threaded end may require a connection kit from Teleflex or the engine manufacturer



1074 Kenran Industrial Dr.  
St. Louis, MO 63137  
Phone: 1-800-381-9968

# HUMCO ENGINE CONTROLS

## Teleflex® Universal 4300/43 & 6400/64 Control Cables

### UNIVERSAL 4300/43 & 6400/64 APPLICATIONS:

Universal type cables are designed to fit aftermarket engine controls as well as OEM units from BMW®, Chrysler®, Honda®, Nissan®, Suzuki®, Volvo®, Yamaha® and others. For heavy duty applications, Teleflex offers 4300/43 and 6400/64 series **TFXtreme** cables.

4300/43 TYPES (1/4-28 ENDS):	
<b>TFXtreme</b> 4300 BC cable	CCX430XX
Cable has one bulkhead and one clamp fitting. There is a 1/4-28 threaded terminal at each end. 3" nominal travel. 5" minimum bend radius.	
<b>TFXtreme</b> 4300 CC cable	CCX433XX
Cable has a 1/4-28 threaded terminal and a clamp-type fitting at each end. 3" nominal travel. 5" minimum bend radius.	
6400/64 TYPES (5/16-24 ENDS):	
<b>TFXtreme</b> 6400 BC cable	CCX640XX
Cable has one bulkhead and one clamp fitting. One 5/16-24 threaded terminal at each end. 4" nominal travel. 8" minimum bend radius.	
<b>TFXtreme</b> 6400 CC cable	CCX643XX
Cable has a 5/16-24 threaded terminal and a clamp-type fitting at each end. 4" nominal travel. 8" minimum bend radius.	
*NOTE: 64 Series cables cannot be replaced by 63 Series cables.	

### FEATURES:

- 4300/43 type cables have stainless steel conduit fittings. (5" minimum bend radius.)
- 6400/64 type cables have stainless steel conduit fittings. (8" minimum bend radius.)
- Black HDPE outer casing for durability and best resistance to UV and chemicals.
- Cables meet/exceed all applicable industry standards

### FOR THESE CONTROLS:

Teleflex Marine® and other brands which accept "universal" type control cables.

6





1074 Kenran Industrial Dr.  
St. Louis, MO 63137  
Phone: 1-800-381-9968

# HUMCO ENGINE CONTROLS

## Teleflex® Universal 4300/43 & 6400/64 Control Cables

### 4300/43 TYPE HEAVY-DUTY CABLES

EXISTING PART NUMBER	DESCRIPTION	PART NUMBER TO REORDER		Conduit Color / End Metal
		Standard	Premium	
CC692XX	<b>TPXTREME</b> 4300BC Control Cable Assembly			black/stainless
All lengths (all markets) superceded to premium <b>TPXTREME</b> cable		N/A	CCX430XX*	black/stainless
CC693XX	<b>TPXTREME</b> 4300CC Control Cable Assembly			black/stainless
All lengths (all markets) superceded to premium <b>TPXTREME</b> cable			CCX433XX*	black/stainless

### 6400/64 TYPE HEAVY-DUTY CABLES

EXISTING PART NUMBER	DESCRIPTION	PART NUMBER TO REORDER		Conduit Color / End Metal
		Standard	Premium	
CC694XX	<b>TPXTREME</b> 6400BC Control Cable Assembly			black/stainless
All lengths (all markets) superceded to premium <b>TPXTREME</b> cable		N/A	CCX640XX*	black/stainless
CC695XX	<b>TPXTREME</b> 6400CC Control Cable Assembly			black/stainless
All lengths (all markets) superceded to premium <b>TPXTREME</b> cable		N/A	CCX643XX*	black/stainless

#### NOTES

XX = Length in feet

4300/43 type cables (1/4-28 end thread) + 3" Travel

6400/64 type cables (5/16-24 end thread) + 4" Travel

64 Series cables cannot be replaced by 63 Series cables.

\*Part Number Change Only.





1074 Kenran Industrial Dr.  
St. Louis, MO 63137  
Phone: 1-800-381-9968

# HUMCO ENGINE CONTROLS

## Teleflex® Jet Boat Control Cables

### JET BOAT APPLICATIONS:

Just for Jets! Two families of jet boat control cables are available, for replacement of Mercury Sport Jet® and OMC Turbo Jet® throttle and reverse-gate cables. **TFXTREME** versions of the three most popular cables are offered for demanding applications in which a smooth feel at the control is essential.

BRP/OMC TURBO JET®:	
<b>THROTTLE CABLES:</b>	
479 type cable (standard)	CC205XX
For OMC Turbo Jets with OMC side mount controls that accept OMC "snap in" O.E.M. type cable. Drop-in replacement cable; uses existing connection components.	
479 type cable ( <b>TFXTREME</b> )	CCX205XX
For OMC Turbo Jets with OMC side mount controls that accept OMC "snap in" O.E.M. type cable. Drop-in replacement cable; uses existing connection components..	
<b>GATE CABLES:</b>	
Turbo Jet cable ( <b>TFXTREME</b> )	CCX214XX
For OMC Turbo Jets with OMC side mount controls that accept OMC "snap in" O.E.M. type cable. Drop-in replacement cable; uses existing connection components.	
Turbo Jet cable ( <b>TFXTREME</b> )	CCX740XX
For OMC Turbo Jets with OMC top mount controls that accept OMC "snap in" O.E.M. type cable. Drop-in replacement cable; uses existing connection components.	
<b>THROTTLE/GATE CABLES (10-32):</b>	
3300 cable	see 3300/33C cables
(For OMC Turbo Jets with OMC binnacle mount, Teleflex or other controls that accept a cable with 10-32 threaded ends. Drop-in replacement cable; uses existing connection components.	

### FEATURES:

- Drop-in replacement cables are engineered as replacements for original equipment cables.
- Cables use the existing connection components.
- Stainless steel and brass fittings.
- Standard cables use stainless steel Lubri-Core™ core wire for smooth operation and long life. (8" minimum bend radius.)
- Midrange cables use a heavier jacket and a stainless steel Lubri-Core™. (8" minimum bend radius for Lubri-Core construction)
- Premium cables have a heavy jacket and the **TFXTREME** splined, coated core element for maximum smoothness with minimal lost motion. (4" min. bend radius.)
- 4300/43 type cables have stainless steel conduit fittings. (5" minimum bend radius.)
- Black HDPE outer casing for durability and best resistance to UV and chemicals.

### FOR THESE CONTROLS:

Mercury SportJet®, OMC TurboJet® Teleflex® CH2300, MV-3 and others

Cables for most jet boat throttle & gate controls

MERCURY SPORT JET®:	
<b>THROTTLE CABLES:</b>	
3300 cable (standard)	CC172XX/ CC230XX
33C cable (midrange)	CC332XX
3300 cable ( <b>TFXTREME</b> )	CCX633XX
3300/33C cables are for Mercury Sport Jets with controls that accept a cable with 10-32 threaded ends. Drop-in replacement cable; requires connection kit #CA27319P for engine end.	
Mercury 3600 type cable ( <b>TFXTREME</b> )	CCX630XX
Cable has a 10-32 threaded terminal at control end and Mercury type engine end. CA27319 kit is not required.	
<b>GATE CABLES:</b>	
90 & early 120 HP:	
Sport Jet 90 & early 120 (standard)	CC213XX
For Mercury Sport Jets with controls which accept a cable with 10-32 threaded ends. Drop-in replacement cable; uses existing connection components.	
<b>175 HP:</b>	
Sport Jet 175 (midrange)	CC400XX
For Mercury Sport Jets with controls which accept a 40BC high-load, stainless steel cable with 1/4-28 threaded end at the control. Drop-in replacement; uses existing connection components.	



1074 Kenran Industrial Dr.  
St. Louis, MO 63137  
Phone: 1-800-381-9968

# HUMCO ENGINE CONTROLS

## Teleflex® Jet Boat Control Cables Cross Reference

EXISTING PART NUMBER	DESCRIPTION	PART NUMBER TO REORDER		Conduit Color / End Metal
		Standard	Premium	
311748-00-XXX.0	40BC Mercury (9-21 feet) Control Cable	CC400XX	N/A	black/stainless
All lengths (all markets) superseded to new part number		CC400XX	N/A	black/stainless
312240-00-XXX.0	Mercury Sport Jet Control Cable	CC401XX	N/A	black/stainless
All lengths (all markets) superseded to new part number		CC401XX	N/A	black/stainless
CC213XX	Jet Boat Shift Control Cable	CC213XX	N/A	black/brass
All lengths (all markets)		CC213XX	N/A	black/brass & stainless
CC692XX	<b>TFX</b> TREME 4300 BC Control Cable Assembly	N/A	CCX430XX	black/stainless
All lengths (all markets) superseded to premium <b>TFX</b> TREME cable		N/A	CCX430XX	black/stainless
CC694XX	<b>TFX</b> TREME 6400BC Control Cable Assembly	N/A	CCX640XX	black/stainless
All lengths (all markets) superseded to premium <b>TFX</b> TREME cable		N/A	CCX640XX	black/stainless

NOTES  
XX = Length in feet

6

CONTROL END

ENGINE END





1074 Kenran Industrial Dr.  
St. Louis, MO 63137  
Phone: 1-800-381-9968

## Teleflex® Panel Control Cables

### UTILITY & VERNIER APPLICATIONS:

UTILITY:	
<b>WITH KNOB AND T-HANDLE:</b>	
Utility Cable (5')	CC34305
Utility Cable (10')	CC34310
Utility Cable (15')	CC34315
Utility Cable (20')	CC34320
Utility Cable (25')	CC34325
Utility Cable (30')	CC34330
Utility Cable (35')	CC34335
Utility Cable (40')	CC34340
VERNIER:	
The vernier cable requires ordering 2 part numbers: a Vernier Cable Head (which includes knob, button, panel body and fine adjustment mechanism) PLUS a Cable, which attaches to the Cable Head.	
Vernier Cable Head	317310
Vernier Cable (5')	CC34505
Vernier Cable (10')	CC34510
Vernier Cable (15')	CC34515
Vernier Cable (20')	CC34520
Vernier Cable (25')	CC34525
Vernier Cable (30')	CC34530
Vernier Cable (35')	CC34535
Vernier Cable (40')	CC34540
CONDUIT FITTING KITS:	
Use these (formerly known as Hub Adapter Kits) to mount utility cables to mount in either bulkhead or clamp type applications.	
Bulkhead Adapter Kit	300673
Clamp Adapter Kit	302485
DC CONTROL:	
Converts standard 3300/33C cable into a utility control. Install through a panel or mount nearly anywhere with optional bracket.	
DC Control	301916
Uses	3300/33C type Cable
Mounting Bracket (stainless steel)	048210

### UTILITY CABLE:

An easy-to-install, easy to operate flexible push-pull cable for remote control of choke, throttle, shut off, fuel valves, vents and many other applications.

- Available with both knob and T-handle.
- Solid stainless steel core wire resists corrosion, moves easily in HDPE liner.
- HDPE outer casing for durability and best resistance to UV and chemicals.

### VERNIER CABLE:

Great for throttles or other applications where precise control is desired. Push the button for fast easy setting of approximate position, then turn the knob for micro adjustment.

- Positive, adjustable brake maintains settings regardless of vibration or governor back pressure.
- Uses standard Teleflex Marine throttle connection kits.
- HDPE outer casing for durability and best resistance to UV and chemicals.

### FOR USE ON:

Remote control of choke, governor, throttle, fuel valves, vents and other applications.

BULKHEAD ADAPTER KIT  
300673



CLAMP ADAPTER KIT  
302485



MOUNTING BRACKET  
048210



3300 CABLE



DC CONTROL (shown with 3300C type cable attached)  
301916





1074 Kenran Industrial Dr.  
St. Louis, MO 63137  
Phone: 1-800-381-9968

# HUMCO ENGINE CONTROLS

## Teleflex® Panel Control Cables Cross Reference

EXISTING PART NUMBER	DESCRIPTION	PART NUMBER TO REORDER		Conduit Color / End Metal
		Standard	Premium	
018872-00-XXX.0	33LU Utility Control Cable w/Knob	CC343XX*	N/A	black/brass
All lengths (NLA - all markets)		CC343XX*	N/A	black/brass
018873-00-XXX.0	33LU Utility Control Cable w/T-handle	CC343XX*	N/A	black/brass
All lengths (NLA - all markets)		CC343XX*	N/A	black/brass
043820-03-XXX.0	33LPL Control Cable, No Hub	N/A	N/A	black/brass
All lengths (NLA - all markets)		OBSOLETE	N/A	
307141-00-XXX.0	33LV Vernier Control Cable No Hub	CC345XX **	N/A	black/aluminum
All lengths (NLA - all markets)		CC345XX **	N/A	black/aluminum
307941-003	Vernier Cable Head	317310***	N/A	N/A
No longer available all markets		317310***	N/A	N/A

NOTES  
 XX = Length in feet  
 \* Contains knob and t-handle  
 \*\* CC345XX cables use 317310 Vernier Control Head  
 \*\*\* Part number change only

6

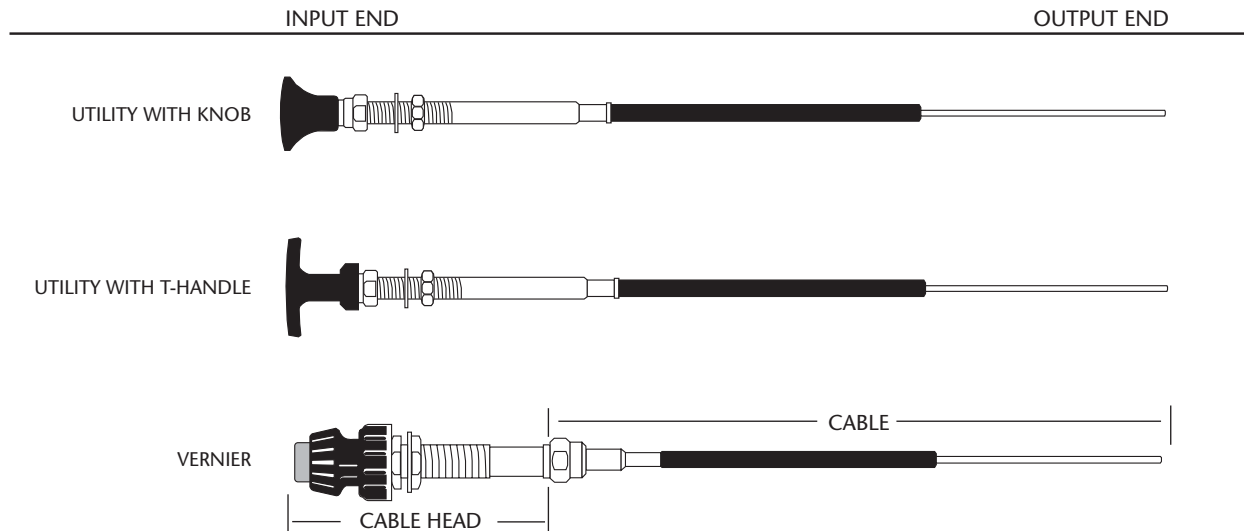



1074 Kenran Industrial Dr.  
St. Louis, MO 63137  
Phone: 1-800-381-9968

# HUMCO ENGINE CONTROLS

## Teleflex® Control Cables Cross Reference

### CROSS-REFERENCE FOR OTHER BRANDS OF CONTROL CABLES:

NAME & MODEL NUMBER	DESCRIPTION (PART NUMBER)	REPLACEMENT (STANDARD)	REPLACEMENT (MIDRANGE)	RECOMMENDED REPLACEMENT (PREMIUM)
<b>MORSE®:</b>				
Type KM	Mercury 1965-date (063732-000) NLA	CC179XX	N/A	CCX179XX
Mercury Sport Jet up to 120	(310530) NLA	CC213XX	N/A	N/A
Mercury Sport Jet 175	(311718-000) NLA	N/A	CC400XX	N/A
Type O	OMC 1979-date (048296-000) NLA	CC205XX	N/A	CCX205XX
Type OS	OMC pre-1979 (302029-000) NLA	CC170XX	N/A	N/A
Type OC	OMC/Volvo new gen. (310048-000) NLA	N/A	N/A	CCX214XX (side mt.) CCX740XX (top mt)
33C	(032377-003) NLA	CC172XX/CC230XX	CC332XX	CCX633XX
33C Supreme	(301947-003) NLA	N/A	CC332XX	CCX633XX
43BC SST & 43BC	(046348-003/038013-003) NLA	N/A	N/A	CCX430XX
43C SST & 43C	(065885-003/038012-003) NLA	N/A	N/A	CCX433XX
63BC XL & 63BC*	(304263-003/037913-003) NLA (3" stroke)	N/A	N/A	N/A
64BC XL & 64BC	(304263-004/037913-004) NLA (4" stroke)	N/A	N/A	CCX640XX
63C XL & 63C*	(304262-003/037912-003) NLA (3" stroke)	N/A	N/A	N/A
64C XL & 64C	(304262-004/037912-004) NLA (4" stroke)	N/A	N/A	CCX643XX (4" stroke)
Positive Lock (3300TL)	Positive Lock (Turn-To-Lock) (043820) NLA	N/A	N/A	N/A
Utility (3300 UT)	Utility Cable (with knob) (018872-00-XXX.0) NLA	N/A	CC343XX**	N/A
Utility (3300 UT)	Utility Cable (with T-handle) (018873-00-XXX.0) NLA	N/A	CC343XX**	N/A
Vernier (3300 VC)	Vernier Cable & Head (separate) (Cable 307141-00-XXX.0 + Head 307941-03) NLA	N/A	CC345XX + Head 317310	N/A
<b>ACCO®:</b>				
OMTS	OMC pre-1979	CC170XX	N/A	N/A
KMTS	Mercury 1965-date	CC179XX	N/A	CCX179XX
M330L	3300CC or 33C type	CC172XX/CC230XX	CC332XX	CCX633XX
M430C	4300CC or 43C type	N/A	N/A	CCX433XX
M430CB	4300BC or 43BC type	N/A	N/A	CCX430XX
M640C	6400CC or 64C type	N/A	N/A	CCX643XX

\* 64 Series cables cannot be used as replacements for 63 Series cables.

\*\* Has both round and T-handle knobs.





1074 Kenran Industrial Dr.  
St. Louis, MO 63137  
Phone: 1-800-381-9968

# HUMCO ENGINE CONTROLS

## Teleflex® Control Cables Cross Reference

General rule: use direct replacement type cable whenever possible;  
use **TFX<sup>XTREME</sup>** cables for difficult routings/multiple stations.

NAME & MODEL NUMBER	DESCRIPTION (PART NUMBER)	REPLACEMENT (STANDARD)	REPLACEMENT (MIDRANGE)	RECOMMENDED REPLACEMENT (PREMIUM)
<b>HI-LEX® (TSK):</b>				
CC33-30-00	3300CC or 33C type	CC172XX/CC230XX	CC332XX	CCX633XX
<b>MERCURY®, MOST MARINER®, LATE MODEL FORCE®:</b>				
Control Cable	(C34555A)	CC179XX	N/A	CCX179XX
Mercury Sport Jet	Mercury Sport Jet 120 HP & lower	CC213XX	N/A	N/A
<b>NW CONTROLS®:</b>				
O Style	OMC pre-1979 (A5119)	CC170XX	N/A	N/A
O2 Style	OMC 1979-date (A6523)	CC205XX	N/A	CCX205XX
M3 Style	Mercury 1965-date (A5153)	CC179XX	N/A	CCX179XX
WW Style	CC172 type (A5124)	CC172XX/CC230XX	CC332XX	CCX633XX
Series 75 W-W	CC330/33C type (A5797)	CC172XX/CC230XX	CC332XX	CCX633XX
Series 95 W-W	33C performance cable (A5805)	N/A	CC332XX	CCX633XX
Series 125 W-W	43C type (A5773)	N/A	N/A	CCX433XX
Series 125 W-WB	43BC type (A5804)	N/A	N/A	CCX430XX
Series 185 W-W	64CC type (A6057)	N/A	N/A	CCX643XX (4" stroke)
Series 185 WB-WB	64BC type (A6064)	N/A	N/A	CCX640XX (4" stroke)
<b>OMC®, BRP®, EVINRUDE®, JOHNSON®, GALE®:</b>				
Long-Life Cable	OMC 1979-date (3773-) (3798-)	CC205XX	N/A	CCX205XX
Snap-In Cable	OMC pre-1979 (1731-)	CC170XX	N/A	N/A
OMC/Volvo New Gen	With OMC controls (M-10)	N/A	N/A	CCX214XX (side mount) CCX740XX (top mount)
<b>VOLVO®:</b>				
Volvo old style	With controls that accept 10-32 end	CC172XX/CC230XX	CC332XX	CCX633XX
OMC/Volvo New Gen.	With OMC controls (M-10)	N/A	N/A	CCX214XX (side mount)
OMC/Volvo New Gen.	With OMC controls (M-10)	N/A	N/A	CCX740XX (top mount)



1074 Kenran Industrial Dr.  
St. Louis, MO 63137  
Phone: 1-800-381-9968

# HUMCO ENGINE CONTROLS

## Teleflex® Control Cables Identification Guide

### TELEFLEX UNIVERSAL CONTROL CABLES IDENTIFICATION GUIDE:











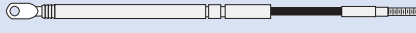





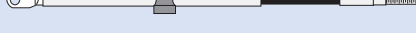





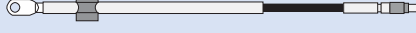







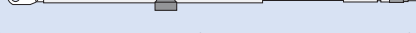

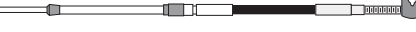



STANDARD	MIDRANGE	PREMIUM
<b>3300/33 UNIVERSAL (10-32 ENDS)</b>	<b>3300/33 UNIVERSAL (10-32 ENDS)</b>	<b>3300/33 UNIVERSAL (10-32 ENDS)</b>
CC172XX/CC230XX	CC332XX	CCX633XX
	CC199XX (NLA) USE PREMIUM CABLE	CCX633XX
	CC223XX (NLA) USE PREMIUM CABLE	CCX633XX
	CC215XX (NLA) USE PREMIUM CABLE	CCX633XX
<b>4300/43 UNIVERSAL (1/4-28 ENDS)</b>	<b>4300/43 UNIVERSAL (1/4-28 ENDS)</b>	<b>4300/43 UNIVERSAL (1/4-28 ENDS)</b>
038012-03-LENGTH 43C (NLA)	065885-03-LENGTH 43C	CCX433XX (4300CC)
CC193XX (4300CC) (NLA)	USE PREMIUM CABLE	CCX433XX (4300CC)
038013-03-LENGTH 43BC (NLA)	046348-03-LENGTH 43BC (NLA)	CCX430XX (4300BC)
CC192XX (4300BC) (NLA)	USE PREMIUM CABLE	CCX430XX (4300BC)
	311748-00-LENGTH 40BC 175 JET CABLE (NLA) USE CC400XX	N/A
<b>63/6400/64 SERIES (5/16-24 ENDS)</b>	<b>63/6400/64 SERIES "XL" (5/16-24 ENDS)</b>	<b>6400/64 SERIES (5/16-24 ENDS)</b>
037912-03-LENGTH 63C (NLA)	304262-03-LENGTH 63CXL (NLA)*	N/A
037912-04-LENGTH 64C (NLA)	304262-04-LENGTH 64CXL (NLA)	CCX643XX (6400CC)
CC195XX (6400CC) (NLA)	USE PREMIUM CABLE	CCX643XX (6400CC)
037913-03-LENGTH 63BC (NLA)	304263-03-LENGTH 63BCXL (NLA)*	N/A
037913-04-LENGTH 64BC (NLA)	304263-04-LENGTH 64BCXL (NLA)	CCX640XX (6400BC)
CC194XX (6400BC) (NLA)	USE PREMIUM CABLE	CCX640XX (6400BC)
NOTE: NLA = "No Longer Available"; N/A = "Not Available".		
* 64 Series control cables cannot replace 63 Series cables.		



1074 Kenran Industrial Dr.  
St. Louis, MO 63137  
Phone: 1-800-381-9968

# HUMCO ENGINE CONTROLS

## Teleflex® Control Cables Identification Guide

CABLE TYPE:	CONTROL END FITS:	ENGINE END FITS:
<b>OEM DIRECT REPLACEMENT TYPE CABLES:</b>		
<b>Mercury®/Mariner® Gen II (2003 to date)</b> Standard: CC189XX, Premium: CCX189XX	 	 Mercury®/MerCruiser®/Force®
<b>Mercury®/Mariner® type 600A (1965 to date)</b> Standard: CC179XX, Premium: CCX179XX	 	 Mercury®, most MerCruiser®, most Mariner® & late model Force®
<b>BRP®/OMC®/Johnson®/Evinrude® type 479 (1979-date)</b> Standard: CC205XX, Premium: CCX205XX	 	 BRP®/OMC® engines
<b>BRP®/OMC®/Johnson®/Evinrude® type 400 (pre-1979)</b> Standard: CC170XX	 	 BRP®/OMC® engines
<b>Mariner® type 40 HP &amp; below (pre-1993)</b> Standard: CC210XX	 	 Mariner® pre-1993 low engines (40 HP & below)
<b>Mercury Sport Jet® (90 &amp; early 120 HP), U.S. Marine® L-drive shift cable</b> Standard: CC213XX	 	 Sport Jet® 90/120 & L-Drive
<b>Mercury Sport Jet® (175 HP)</b> Midrange: 312240-00-XXX.0 (NLA) USE CC401XX	 	 Mercury® Sport Jet® 175
<b>Volvo® engines w/OMC® controls, OMC Turbo Jet®</b> Premium: CCX214XX (side mount), Premium: CCX740XX (top mount)	 	 Volvo® I/O, Turbo, SX; new-gen BRP®/OMC drives; Turbojet® gate cable
<b>Mercury®/Mariner® type 3600 (1965-date)</b> Premium: CCX630XX	 	 controls accepting 10-32 cable ends Mercury®, most MerCruiser®, most Mariner® & late model Force®
<b>UNIVERSAL TYPE CABLES:</b>		
<b>3300/33C type (Teleflex® 3300CC, Morse® 33C/33C Supreme)</b> Standard: CC172XX/CC230XX Midrange: CC332XX Premium: CCX633XX	 	 controls accepting 10-32 cable ends Engines and connection kits that accept a 10-32 threaded end May require connection kit from Teleflex or Engine Manufacturer
<b>4300/43 type (heavy duty applications)</b> Premium: 4300BC (bulkhead-clamp): CCX430XX Premium: 4300CC (bulkhead clamp): CCX433XX	 	 controls accepting 1/4-28 cable ends Engines and connection kits that accept a 1/4-28 threaded end
<b>6400/64 type (heavy duty applications)</b> Premium: 6400BC (bulkhead-clamp): CCX640XX Premium: 6400CC (bulkhead clamp): CCX643XX	 	 controls accepting 5/16-24 cable ends Engines and connection kits that accept a 5/16-24 threaded end
<b>PANEL MOUNT TYPE CABLES:</b>		
<b>Utility (with knob: 018872-00-XXX.0) NLA (with T-handle: 018873-00-XXX.0) NLA USE CC343XX</b> Has both the round and T-handle knobs	 	 Vernier (micro-adjustable; CC345XX + 317310 Control Head)



1074 Kenran Industrial Dr.  
St. Louis, MO 63137  
Phone: 1-800-381-9968

# HUMCO ENGINE CONTROLS

## Teleflex® Control Cable Connection Kits

### CONTROL CONNECTION KITS

#### OEM Control-Specific Connection Kits for 3300/33C cables

Description	Part No.
Merc/Mariner Control Adapter - 3300/33C cable	301074
OMC//E Control Adapter - 3300/33C cable	304939

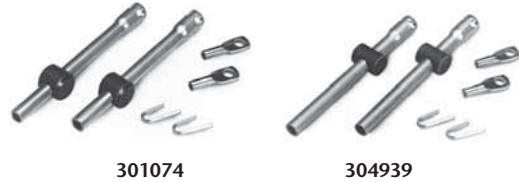

301074

304939

### ENGINE CONNECTION KITS

#### Engine-Specific Connection Kits for 1973-1978 OMC OEM ("400" type) cables with bare wire ends:

Evinrude/Johnson O/B Kit (35HP & less)	CA27208P
Evinrude/Johnson O/B Kit (over 35HP)	CA27247P
OMC Stern Drive Kit (all)	CA27247P

(NOTE: included clip is not used on stern drives.)



CA27247P

#### Engine-Specific Connection Kits for 3300/33C cables

Evinrude/Johnson O/B Kit (1979-date)	CA27320P
Evinrude/Johnson O/B Kit (pre-1979)	CA27321P
Mercury Outboard Kit (1965-date)	CA27319P
Mercury Stern Drive Kit (all)	CA27319P
Mercury Inboard Kit (all)	CA27373P
OMC Stern Drive Kit (all)	CA27320P



CA27320P



CA27373P

#### Universal Ball Joint Kits

Univ. 3300/33C Ball Joint (1/4-28) (1)	CA37701P
Univ. 3300/33C Ball Joint (10-32) QR (1)	031799-001
Univ. 3300/33C Ball Joint (1/4-28) QR (1)	031126
Univ. 3300/33C Ball Joint (5/16-24) QR (1)	035242
Univ. 4300/43 Ball Joint (1/4-28) (1)	CA28014P
Univ. 4300/43 Ball Joint (1/4-28) QR (1)	029104
Univ. 4300/43 Ball Joint (5/16-24) QR (1)	032267
Univ. 6400/64 Ball Joint (5/16-24) (1)	CA28021P
Univ. 6400/64 Ball Joint (5/16-24) QR (1)	029108
Univ. 6400/64 Ball Joint (5/16-24) ST (1)	038491

Teleflex Type  
CA37701P



ST Type  
038491



QR Type  
029104



(NOTE: QR type has external spring over ball receptor; ST does not.)



1074 Kenran Industrial Dr.  
St. Louis, MO 63137  
Phone: 1-800-381-9968

# HUMCO ENGINE CONTROLS

## Teleflex® Control Cable Connection Kits

### CABLE CONNECTION KITS

For two cables, except where otherwise noted.  
(1) = for use with one cable.

#### Universal Clevis Kits

Description	Part No.
Univ. 3300/33C Clevis (10-32, 1/4" pin) (1)	031125
Univ. 3300/33C Clevis (10-32, 3/16" pin) (1)	031800
Univ. 3300/33C Clevis (10-32, 1/4" pin) (1)	031125
Univ. 3300/33C Clevis (10-32, 5/16" pin) (1)	033395
Univ. 4300/43 Clevis (1/4-28, 1/4" pin) (1)	029025
Univ. 4300/43 Clevis (1/4-28, 5/16" pin) (1)	042212
Univ. 4300/43 Clevis (1/4-28, 5/8" pin) (1)	045985
Univ. 6400/64 Clevis (5/16-24, 5/16" pin) (1)	029132-001
Univ. 6400/64 Clevis (5/16-24, 3/8" pin) (1)	042034



#### Other Universal Cable Connection Kits

##### Pivots – 3300/33C Series:

	A	B	C	D	E	
in	3/16	7/16	3/8	9/64	11/16	045583
mm	4.8	11.1	9.5	3.6	17.5	
in	1/4	7/16	21/64	9/64	5/8	031029
mm	6.4	11.1	8.3	3.6	15.9	
in	1/4	7/16	3/8	.191	23/32	031539
mm	6.4	11.1	9.5	4.9	18.3	
in	1/4	7/16	21/64	.295	25/32	032392
mm	6.4	11.1	8.3	7.5	19.8	
in	1/4	7/16	3/8	.316	15/16	039890
mm	6.4	11.1	9.5	8.0	23.8	
in	1/4	1/2	3/8	.376	15/16	043939
mm	6.4	12.7	9.5	9.6	23.8	
in	5/16	7/16	3/8	13/32	1-1/16	037691
mm	7.9	11.1	9.5	10.3	27.0	
in	5/16	7/16	3/8	7/16	1	039471
mm	7.9	11.1	9.5	11.1	25.4	

##### Pivots – 4300/43 Series:

in	1/4	1/2	7/16	9/64	3/4	039110
mm	6.4	12.7	11.1	3.6	19.1	
in	1/4	1/2	1/2	13/64	7/8	031537
mm	6.4	12.7	12.7	5.2	22.2	
in	1/4	1/2	1/2	17/64	15/16	036361
mm	6.4	12.7	12.7	6.7	23.8	
in	5/16	1/2	9/16	9/64	29/32	045199
mm	7.9	12.7	14.3	3.6	23.0	
in	3/8	9/16	1/2	25/64	13/16	042419
mm	9.5	14.3	12.7	9.9	20.6	

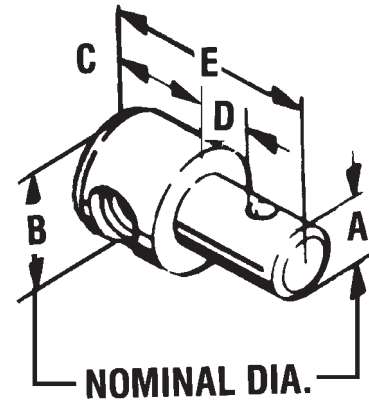





1074 Kenran Industrial Dr.  
St. Louis, MO 63137  
Phone: 1-800-381-9968

# HUMCO ENGINE CONTROLS

## Teleflex® Control Cable Connection Kits

### CABLE CONNECTION KITS (Cont.)

#### Other Universal Cable Connection Kits, continued

Description	Part No.
<b>3300/33C Series:</b>	
Eye Terminal (Metal) – 3300 (10-32, 5/16" pin) (1)	317413
Eye Terminal (Red Nylon) – 3300 (10-32, 5/16" pin) (1)	300646
<b>4300/43 Series:</b>	
Eye Terminal – 4300/43 (1/4-28, 5/16" pin) (1)	041134
<b>6400/64 Series:</b>	
Eye Terminal – 6400/64 (5/16-24, 5/16" pin) (1)	045428
Pin for Eye Terminal (1.5", 5/16" dia.) (pin only)	300965
Pin for Eye Terminal (1.687", 5/16" dia.) (pin only)	047383
Terminal Pin Kit (300965, ring, nut, washer)	301456
Spring Link Terminal	031545
Univ. 3300/33C Clamp & Shim Kit (1)	CA28020P
Univ. 3300/33C Clamp (1)	032010
3300/33C Clamp (for bare conduit) (1)	037664
3300/33C Clamp (for bare cond. or ftg.) (1)	031509
3300/33C Clamp Shim for 032010 (1)	035777
Univ. 4300/43 Clamp & Shim Kit (1)	CA28018P
Univ. 4300/43 Clamp – 2 Holes (1)	031532
Heavy Duty 4300/43 Clamp – 4 Holes (1)	021227
4300/43 Clamp Shim for 031532 & 021227 (1)	031538
(NOTE: 2 shims required for each 021227 clamp.)	
Univ. 6400/64 Clamp & Shim Kit (1)	CA28019P
Heavy Duty 6400/64 Clamp – 4 Holes (1)	036733
6400/64 Clamp Shim (1)	031538
Univ. 3300/33C Inboard Connection Kit (2)	CA27024P
(Above contains: (2) CA37701P Ball Joints & (2) 031419 Brackets.)	
Univ. 3300/33C Inboard Connection Bracket (1)	036174
(Old Morse® description: "Cable Hook Clip – Single")	
Univ. 3300/33C Inboard Connection Bracket (1)	031419
(Old Morse® description: "Cable Clip – 30 Series Only")	
Univ. 3300/33C Cable Clip DS	035531
(Old Morse® description: "Cable Hook Clip – Dual")	

EYE TERMINAL  
317413



EYE TERMINAL PIN  
300965



CLAMP  
032010



CLAMP &  
SHIM KIT  
CA28018P



036174  
031419



CA27024P



035531



#### Other Cable Kits/Accessories

Anti-Vibration Cable Mount – 3300/33C	294200-001
Anti-Vibration Cable Mount – 4300/43	294201-001
Stop Collar – 3300/33C	037693
Cable Brake – 3300/33C, 4300/43 & 6400/64 Cables	044386

ANTI-VIBRATION CABLE  
MOUNT

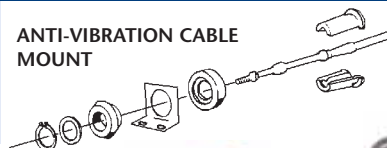

CABLE BRAKE  
044386



STOP COLLAR  
037693





1074 Kenran Industrial Dr.  
St. Louis, MO 63137  
Phone: 1-800-381-9968

# HUMCO ENGINE CONTROLS

## Teleflex® Control Cable Connection Kits

### CABLE CONNECTION KITS (Cont.)

#### Conduit Fitting [Hub] Adapter Kits for Panel/Utility Cables

Description	Part No.
Bulkhead Adapter Kit – Panel Cables	300673
Clamp Adapter Kit – Panel Cables	302485



#### All-Purpose Clutch & Throttle Kits – BY PART NUMBER

Connection Kit –3300/33C Cable	036680
Connection Kit – 4300/43 Cable	040773
Connection Kit – Dual Station 3300/33C (TwinDisc)	042577
Clutch Kit – Twin Disc (right)	063696
Throttle Kit –3300/33C Cable (Cummins)	300580
Adapter Kit –4300/43 Cable (Cummins, GM, Borg-Warner, Twin Disc)	300580

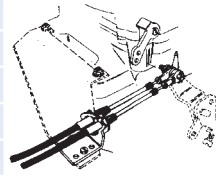

036680

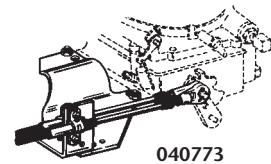

040773

### PRE-ENGINEERED CLUTCH & THROTTLE KITS – BY ENGINE APPLICATION

#### For Single Station 3300/33C Cables

Caterpillar 334, 3304 & 3306	036680
Caterpillar 343, 3406 & 3408	036680
Cummins (all with MVSGOV)	036680
Cummins (V, VT, KT, KTA 1975-up)	300580
GM (2, 3 & 4-53 w/left & right hand gov.)	036680
GM (GV-53 rear & front entry)	036680
GM (6 & 8V-71 front entry shutdown kit)	036680
Universal (Atomic 4)	036680
Universal (Atomic 1&2 63C clutch & 33C throttle)	036680

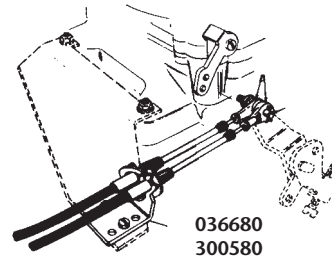

036680  
300580

#### For Dual Station 4300/43C Cables

Caterpillar 334, 3304 & 3306	036680
Caterpillar 343, 3406 & 3408	036680
Cummins (all with MVSGOV)	036680
Cummins (V, VT, KT, KTA 1975-up)	300580
GM (2, 3 & 4-53 w/left & right hand gov.)	036680
GM (GV-53 rear & front entry)	036680
GM (6 & 8V-71 front entry shutdown kit)	036680
Universal (Atomic 4)	036680
Universal (Atomic 1&2 63C clutch & 33C throttle)	036680

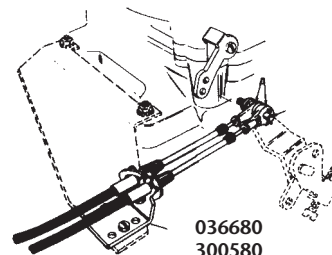

036680  
300580

#### To convert from 3300/33C Dual Station to 4300/43C Dual Station, add

Caterpillar 334, 3304 & 3306	040773
Caterpillar 343, 3406 & 3408	040773
Cummins (all with MVSGOV)	040773

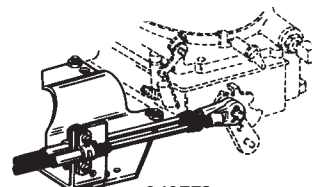

040773  
300665

(listing continued on page 427)



1074 Kenran Industrial Dr.  
St. Louis, MO 63137  
Phone: 1-800-381-9968

# HUMCO ENGINE CONTROLS

## Teleflex® Control Cable Connection Kits

### PRE-ENGINEERED CLUTCH & THROTTLE KITS – BY ENGINE APPLICATION (Cont.)

To convert from 3300/33C Dual Station to 4300/43C Dual Station, add

Description	Part No.
Cummins (V, VT, KT, KTA 1975-up)	300665
GM (3,4 & 6-71 w/var. spd. Gov.)	300665
GM (6, 8 & 12 V-71, 6 & 8 V-92 w/v.s.g.)	300665
GM (2, 3 & 4-53 w/left & right hand gov.)	040773
GM (GV-53 rear & front entry)	040773
GM (6 & 8V-71 front entry shutdown kit)	040773
Universal (Atomic 4)	040773
Universal (Atomic 1&2 63C clutch & 33C throttle)	040773

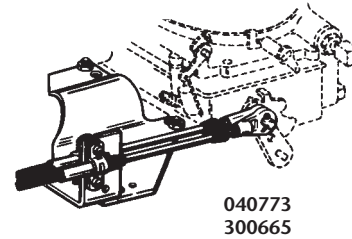

### PRE-ENGINEERED CLUTCH & THROTTLE KITS – BY TRANSMISSION

For Dual Station 3300/33C Cables

Borg-Warner (70, 71 & 72 inline-red gear)	301474
Capital (12400, 2, 3 & 4 HD & HE)	036680
Paragon (HF-7)	036680
Twin Disc (MG, 508, 509, 510, 510A, 512)	042577
Twin Disc (514C, 514CHP, 518, 521, 527)	042577
Twin Disc (530 & 540)	042577
Twin Disc (MG502, 506 & 507)	063696

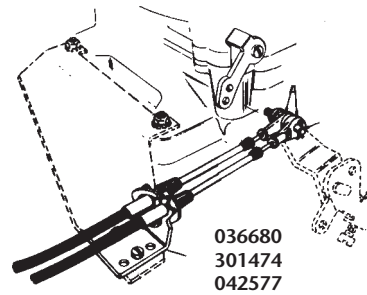

For Dual Station 4300/43C Cables

Borg-Warner (70, 71 & 72 inline-red gear)	301474
Capital (12400, 2, 3 & 4 HD & HE)	036680
Paragon (HF-7)	036680

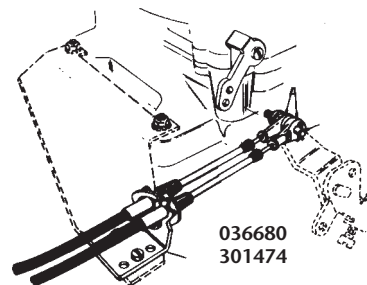

To convert from 3300/33C Dual Station to 4300/43C Dual Station, add

Borg-Warner (70, 71 & 72 inline-red gear)	300665
Borg-Warner (71C & 72C drop center)	300665
Capital (12400, 2, 3 & 4 HD & HE)	040773
Paragon (HF-7)	040773
Twin Disc (MG, 508, 509, 510, 510A, 512)	300665
Twin Disc (514C, 514CHP, 518, 521, 527)	300665
Twin Disc (530 & 540)	300665
Twin Disc (MG502, 506 & 507)	300665

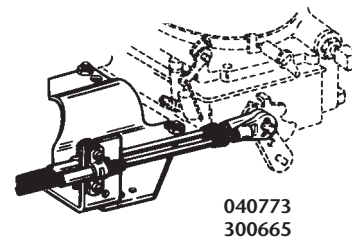

For two cables, except where otherwise noted. (1) = for use with one cable.